

euroBLADE S2

DESIGN SPECS

europanel
acoustic solutions

AVAILABLE IN:

- Solid timber with clear satin finish
- Solid timber with white wash finish
- Solid timber with stained finishes with clear satin
- Any polyurethane colour from the Dulux range with satin finish
- Prefinished laminate colours on EO MDF battens

GENERAL WEIGHTS PER M²:

Western Red Cedar	11kg/m ²
American White Oak & Tasmanian Oak	15kg/m ²
Spotted Gum & Blackbutt	19kg/m ²
Polyurethane on MDF	18kg/m ²
Prefinished laminate	18kg/m ²

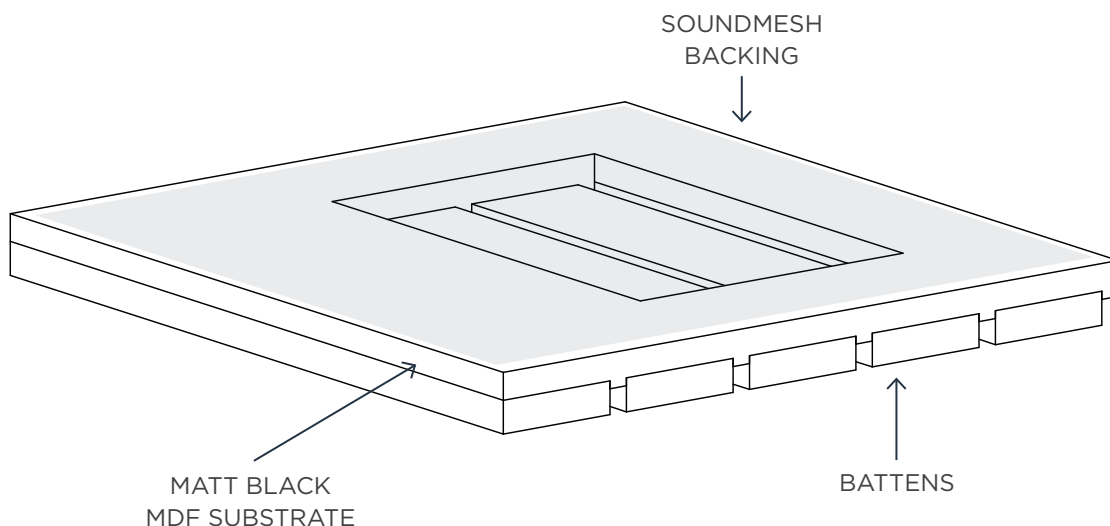

BATTEN SIZES AND SPACINGS CAN BE CUSTOMISED TO SUIT YOUR DESIGN CONCEPT

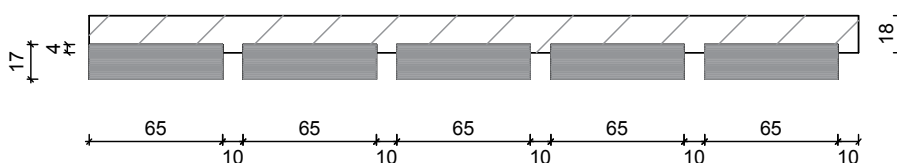

How to specify

EXAMPLE SPECIFICATION:

EB-S2-T-WESTERN RED CEDAR

PRODUCT	DESIGN	FINISH	OTHER
EB euroBLADE	S# Standard C# Custom	T Timber PR Prefinished PO Polyurethane	? Species/colour

COMPLETE YOUR DESIGN WITH **EUROPANEL**
HELPLINE 02 8284 6410 WWW.EUROPANEL.COM.AU